

# **enduraPRESS™ SD20**

## **USER MANUAL**



## Table of Contents

**Page**

<b>1</b>	<b>Specifications</b>
<b>2</b>	<b>Operation Instructions Read Before Use</b>
<b>3</b>	<b>Control Panel Operation IT9300</b>
<b>4</b>	<b>Control Panel Operation IT9500</b>
<b>5</b>	<b>Calibrating the Temperature Display on IT9500</b>
<b>6</b>	<b>Leveling the Bed</b>
<b>7</b>	<b>SD20 Support Bracket and Regular Maintenance</b>
<b>8</b>	<b>Heat Transfer Application Guidelines</b>
<b>9</b>	<b>Troubleshooting Tips</b>
<b>10</b>	<b>Wiring Schematic</b>



## Specifications:

Model NO: ENDURAPRESS SD20

Voltage: 120V/60Hz

Power: 15.5A, 1700W,

Control Panel: LCD Control Panel

Time Range: 0~999sec.

Temp. Range: 0~480°F

Max Open Height: 0.5"

Packaging: Double-walled Corrugated Paper Carton

Gross Weight: 126lbs (57kg)



Power Switch



Breaker

## Operation Instructions Read Before Use

1. Check the voltage before using it. The correct voltage is 110-120V/60Hz
2. Turn off the machine when not in use, and remove the power plug from socket.
3. Grasp the handle firmly when opening.
4. Keep children away from the machine.
5. Do not touch the heating platen and platen cover after pressing whilst in operation
6. Do not attempt to press products that are not intended for normal heat transfer
7. Do not set the temperature any higher than 480F as it may cause over heat and stop working.
8. The heat press carries a ground line by default, please make sure the socket gets a ground line protector.

## Control Panel Operation IT9300



**Touch Screen Control Panel.**  
Touch "Set" to activate menu.



**Page 1: Temperature.**  
Touch up or down arrow to adjust temperature.



**Page 2: Time:**  
Touch up or down arrow to adjust cycle time



**Page 3: Celsius or Fahrenheit.**  
Touch up or down arrow to change temp display from Fahrenheit to Celsius.



### **Page 4: Temperature Calibration.**

Touch up or down arrow to adjust displayed temperature reading to match actual (measured) heat platen temperature. For instance, if display reads 200° and actual temperature is 210°, set +10 here using up arrow.



### **Page 5: Pre-Alarm Setting.**

Touch up or down arrow to set off the end-of-cycle alarm before the end of cycle. This feature is helpful for hot peel applications requiring immediate action at the end of the cycle. The pre-alarm gives you time to prepare.

## Control Panel Operation IT9500

NEW

V-02 CONTROLLER PROGRAM



Control Panel Window



P-1: Temp. Setting Mode.  
Touch SET & ▲/▼ keys to set desired temp



P-2: Time Setting Mode.  
Touch SET & ▲/▼ keys to set desired time



P-3: Touch SET & ▲ or ▼. Choose °C or °F.





P-4: Auto Power-off Mode  
Touch SET & ▲/▼ keys to set auto-off time with 0~120 min range



Heat press enters into power off mode if machine is kept quietly for set time and without any operation



User can wake up heat press and start heating by touching any key

WHAT DOES AUTO POWER-OFF DO?



ENERGY SAVING



SAFETY ASSURED

## Calibrating the Temperature Display on IT9500

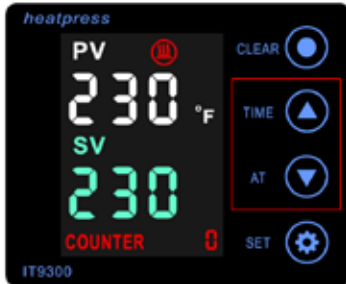

Touch ↑ & ↓ buttons for 8 sec.



Gauge enters into a window like above picture

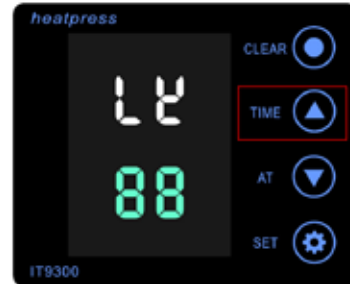

Touch ↑ button and plus to 88



Touch SET button till you find a window like above picture



Touch ↑ & ↓ button to determine the Temp. will be modified, Say -30F (i.e. heating platen 30F cooler than the gauge read-out)

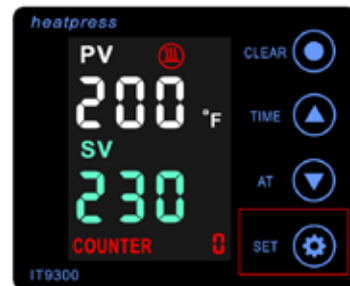

Touch SET key to back to window and read-out 200F, and heat press will continue to heats up to 230F



Touch ↑ & ↓ button to determine the Temp. will be modified, Say. 30F (i.e. heating platen 30F hotter than the gauge read-out)

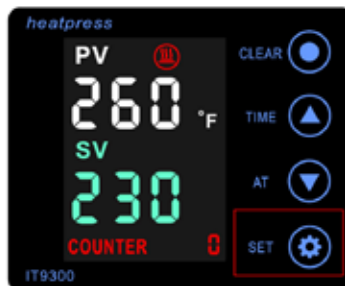

Touch SET key to back to window and read-out 260F, and heat press will cooler down to 230F finally



## Leveling the Bed

The SD20 comes with a mechanism designed to help you ensure that the bed is perfectly level front-to-back and side-to-side. There are adjustable bolts under each corner that can be adjusted with an allen wrench to raise or lower the lower platen. In order to make the adjustment, you will need an 8mm allen wrench. Here are the steps.

- 1) Set the pressure in the medium range
- 2) Place four sheets of paper on the bed, one on each corner
- 3) Close the press and try to pull the sheets free, one at a time.
- 4) If one or more of the sheets can be removed, or if there are varying levels of resistance, the bed is not perfectly level.
- 5) Use pliers to loosen the locking nuts. Then use the allen wrench to raise or lower the four corner bolts. Test again with the press closed on the four sheets of paper until resistance is even at all four corners. Re-tighten the locking nuts to secure the bolts in their new position.
- 7) Turn the large central knob clockwise to lock in the new bed height.

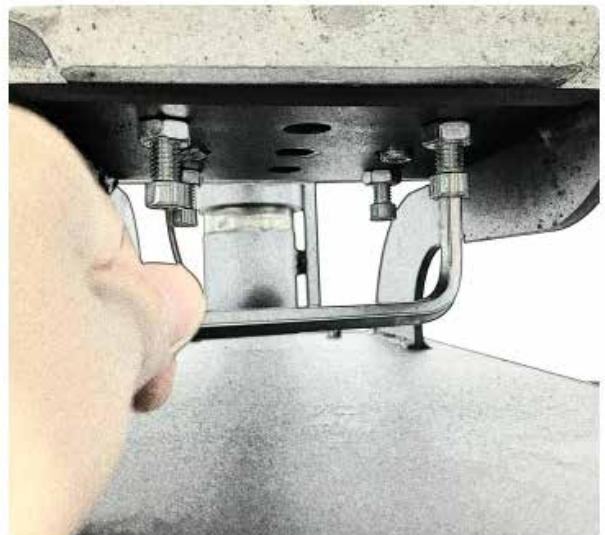
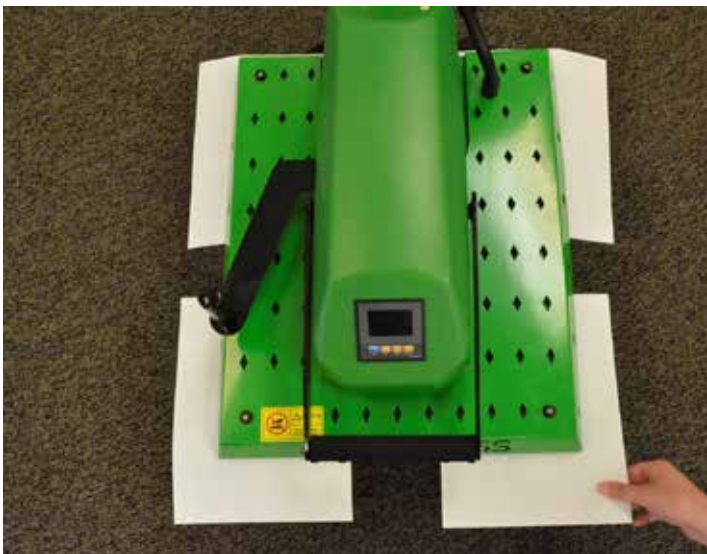



## SD20 Support Brackets

There are two sets of brackets added to provide more support for the base. This is intended to reduce the risk that the press may become top-heavy and unstable. If you experience any incidence of instability when the press is rotated at 180° away from the closed position, attach the bracket extensions to extend and secure the base of the heat press.

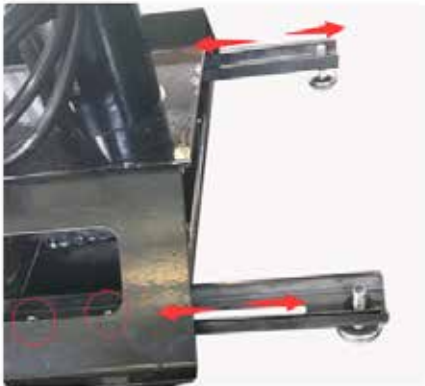

To extend brackets, first loosen the nuts indicated at left. Then slide the brackets out from the frame to the desired extent. When you have extended the brackets, re-tighten the nuts to secure them.



The brackets are height-adjustable. Simply turn the feet clockwise or counter-clockwise to extend or retract the feet and raise or lower the brackets. Adjust these to set the bracket height parallel to the table so that the entire base of the heat press is level and parallel with the work table. Caution! Only use the heat press on a secure, stable work surface! Placing it on an unstable surface such as a folding or temporary table may degrade performance and cause risk of injury.

## Regular Maintenance

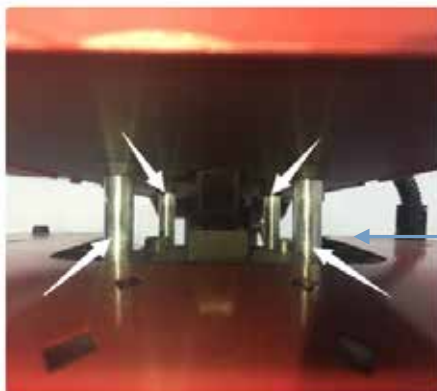

There are two points on the SD20 that should be lubricated regularly to maintain good performance. Use a standard lubricant such as WD40 or 3-in-1 oil. Use lubricating oil for regular maintenance for these 4 columns above the heating cover.



Use lubricating oil for regular maintenance for the swing-arm column.

## Heat Transfer Application Guidelines

These are general guidelines. For specific time and temperature settings for specific films and/or transfer papers, please refer to the instructions for that particular product.

TRANSFERS	Device	Fabric	TEMP.	TIME	PRESSURE
Sublimation Paper	Ricoh, Epson	Polyester	400°F	25~30sec.	30Psi
Ink Tran. Paper	Inkjet Printer	Light Color	365°F	15sec.	30Psi
		Dark Color	330°F	25sec.	30Psi
Laser Transfer Paper**	Laser Printer	Light Color	345°F	30sec.	30Psi
	Laser Printer	Dark Color	260 - 320°F	35 - 120 sec.	25Psi
Transfer Vinyls	Cutting Plotter	/	300~320°F	8~10sec.	30Psi
Plastisol Transfer	/	/	335°F	12sec.	50Psi

\*\* The EnduraPRESS CS15, CS15-AR, CS16, and CS16-AR are not recommended for use with two-step laser transfer papers. For these demanding applications, we recommend the EnduraPRESS SA12 or SD20.

## Troubleshooting Tips

Q. Why isn't my heat transfer vinyl sticking to the fabric?

A. This can be caused by three things. Insufficient pressure, or temperature, or time.

Time: Some heat transfer films need a few seconds to cool before you remove the liner. Try a warm or cold peel first.

Temperature: If that doesn't work, check to make sure you are using the recommended time and temperature settings. If you are, your press may not be putting out the correct amount of heat. Use a Geo Knight IR thermometer to check the actual temperature of the platen. If it is more than 5° different from the LCD display (PV), adjust it using step four in the control panel (see page 4).

Pressure: If the temperature is correct, adjust the pressure. Some films require more pressure to bond the adhesive to the fabric. There should be some resistance when you close the press. If you have verified all of these and the film doesn't stick, contact SIGNWarehouse customer service or Technical Support for further assistance.

Q. Why does my sublimated transfer look washed out?

A. This is usually caused by insufficient temperature. Sublimation works best at or near 400°F. If your transfer is faded, check the output of the heat platen with a contact thermometer and make sure the output matches the displayed temperature. If not, adjust as directed above. Then repress at 390 - 400°F.

Q. Why are my transfers are sticking to the heating element of the upper platen?

A. If T-shirt vinyl is sticking to the heating element, you have it upside down. Remove any adhesive residue, flip it over and try again. If an inkjet or laser transfer is sticking to the heating element, it's because the heat is affecting the ink. Cover it with a Teflon sheet or sheet of silicone Kraft paper to prevent this. Using a Teflon sheet or Kraft paper is recommended for almost all heat transfer applications.

Q. Why is it so hard to peel the liner when I'm done pressing the paper?

A. A hot or warm peel film may become hard to peel if allowed to cool. Always peel the film or transfer paper in accordance with the product's recommendations.

## Wiring Schematic

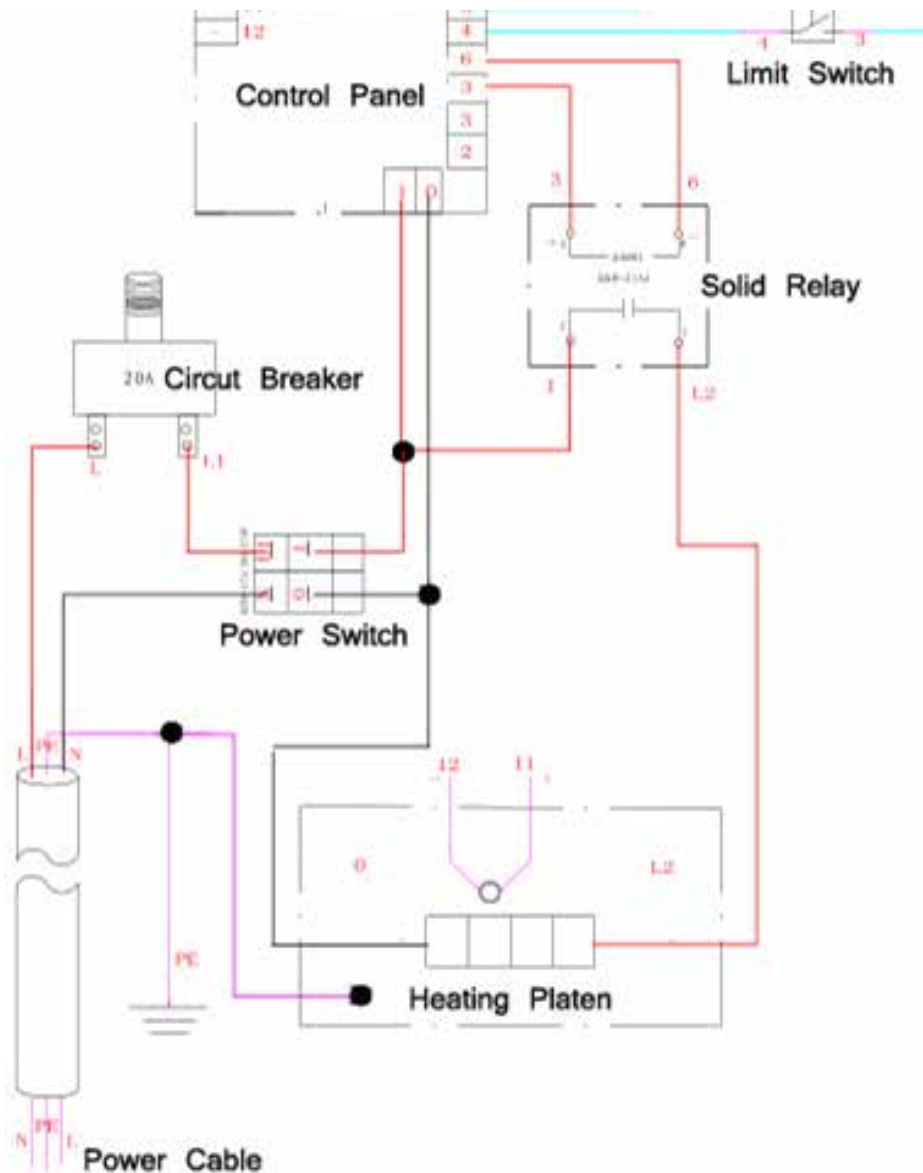

## WARRANTY

Thank you for choosing our products, you are entitled to one year free warranty service for our products. All exceeds warranty period we will still provide technical supports and maintenance guidance.